



Product designation				Power contactor
Product type designation				BF50
<b>Contact characteristics</b>				
Number of poles	Nr.			3
Rated insulation voltage U <sub>i</sub> IEC/EN	V			1000
Rated impulse withstand voltage U <sub>imp</sub>	kV			8
Operational frequency	min	Hz	25	
	max	Hz	400	
IEC Conventional free air thermal current I <sub>th</sub>	A			90
Operational current I <sub>e</sub>	AC-1 (=40°C)	A	90	
	AC-1 (=55°C)	A	75	
	AC-1 (=70°C)	A	65	
	AC-3 (=440V =55°C)	A	50	
	AC-4 (400V)	A	28	
Rated operational power AC-3 (T=55°C)	230V	kW	11	
	400V	kW	22	
	415V	kW	22	
	440V	kW	22	
	500V	kW	22	
	690V	kW	30	
	1000V	kW	18.5	
Rated operational power AC-1 (T=40°C)	230V	kW	34	
	400V	kW	59	
	500V	kW	74	
	690V	kW	102	
IEC max current I <sub>e</sub> in DC1 with L/R = 1ms with 1 poles in series	=24V	A	45	
	48V	A	40	
	75V	A	40	
	110V	A	8	
	220V	A	-	
IEC max current I <sub>e</sub> in DC1 with L/R = 1ms with 2 poles in series	=24V	A	60	
	48V	A	60	
	75V	A	60	
	110V	A	50	
	220V	A	7	
IEC max current I <sub>e</sub> in DC1 with L/R = 1ms with 3 poles in series	=24V	A	60	
	48V	A	60	
	75V	A	60	

	110V	A	55
	220V	A	75
<hr/>			
IEC max current I <sub>e</sub> in DC1 with L/R = 1ms with 4 poles in series			
	=24V	A	60
	48V	A	60
	75V	A	60
	110V	A	60
	220V	A	90
<hr/>			
IEC max current I <sub>e</sub> in DC3-DC5 with L/R = 15ms with 1 poles in series			
	=24V	A	30
	48V	A	25
	75V	A	22
	110V	A	3
	220V	A	–
<hr/>			
IEC max current I <sub>e</sub> in DC3-DC5 with L/R = 15ms with 2 poles in series			
	=24V	A	35
	48V	A	35
	75V	A	30
	110V	A	25
	220V	A	5
<hr/>			
IEC max current I <sub>e</sub> in DC3-DC5 with L/R = 15ms with 3 poles in series			
	=24V	A	50
	48V	A	50
	75V	A	45
	110V	A	30
	220V	A	40
<hr/>			
IEC max current I <sub>e</sub> in DC3-DC5 with L/R = 15ms with 4 poles in series			
	=24V	A	55
	48V	A	55
	75V	A	55
	110V	A	45
	220V	A	50
<hr/>			
Short-time allowable current for 10s (IEC/EN60947-1)		A	400
<hr/>			
Protection fuse			
	gG (IEC)	A	100
	aM (IEC)	A	50
<hr/>			
Making capacity (RMS value)		A	500
<hr/>			
Breaking capacity at voltage			
	440V	A	400
	500V	A	352
	690V	A	312
<hr/>			
Resistance per pole (average value)		m?	0.8
<hr/>			
Power dissipation per pole (average value)			
	I <sub>th</sub>	W	6.5
	AC3	W	2
<hr/>			
Tightening torque for terminals			
	min	Nm	4
	max	Nm	5
	min	I <sub>bin</sub>	2.95
	max	I <sub>bin</sub>	3.69
<hr/>			
Tightening torque for coil terminal			
	min	Nm	0.8
	max	Nm	1

	min	I <sub>bin</sub>	0.8
	max	I <sub>bin</sub>	0.74
Max number of wires simultaneously connectable		Nr.	2
Conductor section			
AWG/Kcmil			
	max		2
Flexible w/o lug conductor section			
	min	mm <sup>2</sup>	1.5
	max	mm <sup>2</sup>	35
Flexible c/w lug conductor section			
	min	mm <sup>2</sup>	1.5
	max	mm <sup>2</sup>	35
Power terminal protection according to IEC/EN 60529			IP20 front
<b>Mechanical features</b>			
Operating position	normal allowable		Vertical plan ±30°
Fixing			Screw / DIN rail 35mm
Weight		g	1020
Conductor section			
AWG/kcmil conductor section			
	max		2
<b>Operations</b>			
Mechanical life		cycles	15000000
Electrical life		cycles	1400000
<b>Safety related data</b>			
Performance level B10d according to EN/ISO 13489-1			
	rated load	cycles	1400000
	mechanical load	cycles	15000000
Mirror contacts according to IEC/EN 60947-4-1			yes
EMC compatibility			yes
<b>AC coil operating</b>			
Rated AC voltage at 60Hz		V	24
AC operating voltage			
of 60Hz coil powered at 60Hz			
pick-up	min	%U <sub>s</sub>	80
	max	%U <sub>s</sub>	110
drop-out	min	%U <sub>s</sub>	20
	max	%U <sub>s</sub>	55
AC average coil consumption at 20°C			
of 60Hz coil powered at 60Hz			
	in-rush	VA	210
	holding	VA	15
Dissipation at holding =20°C 50Hz		W	5
<b>Max cycles frequency</b>			
Mechanical operation		cycles/h	3600
<b>Operating times</b>			
Average time for U <sub>s</sub> control			
in AC			
			Closing NO

		min	ms	12
		max	ms	28
	Opening NO			
		min	ms	8
		max	ms	22
<hr/>				
in DC				
	Closing NO			
		min	ms	40
		max	ms	85
	Opening NO			
		min	ms	20
		max	ms	55

**UL technical data**

Full-load current (FLA) for three-phase AC motor

at 480V	A	52
at 600V	A	41

Yielded mechanical performance

for single-phase AC motor

110/120V	HP	5
230V	HP	10

for three-phase AC motor

200/208V	HP	15
220/230V	HP	20
460/480V	HP	40
575/600V	HP	40

General USE

Contactor

AC current	A	90
------------	---	----

Short-circuit protection fuse, 600V

High fault

Short circuit current	kA	100
Fuse rating	A	150
Fuse class		J

Standard fault

Short circuit current	kA	5
Fuse rating	A	150
Fuse class		RK5

**Ambient conditions**

Temperature

Operating temperature

min	°C	-50
max	°C	70

Storage temperature

min	°C	-60
max	°C	80

Max altitude

m	3000
---	------

**Resistance & Protection**

Pollution degree

3

**Dimensions**

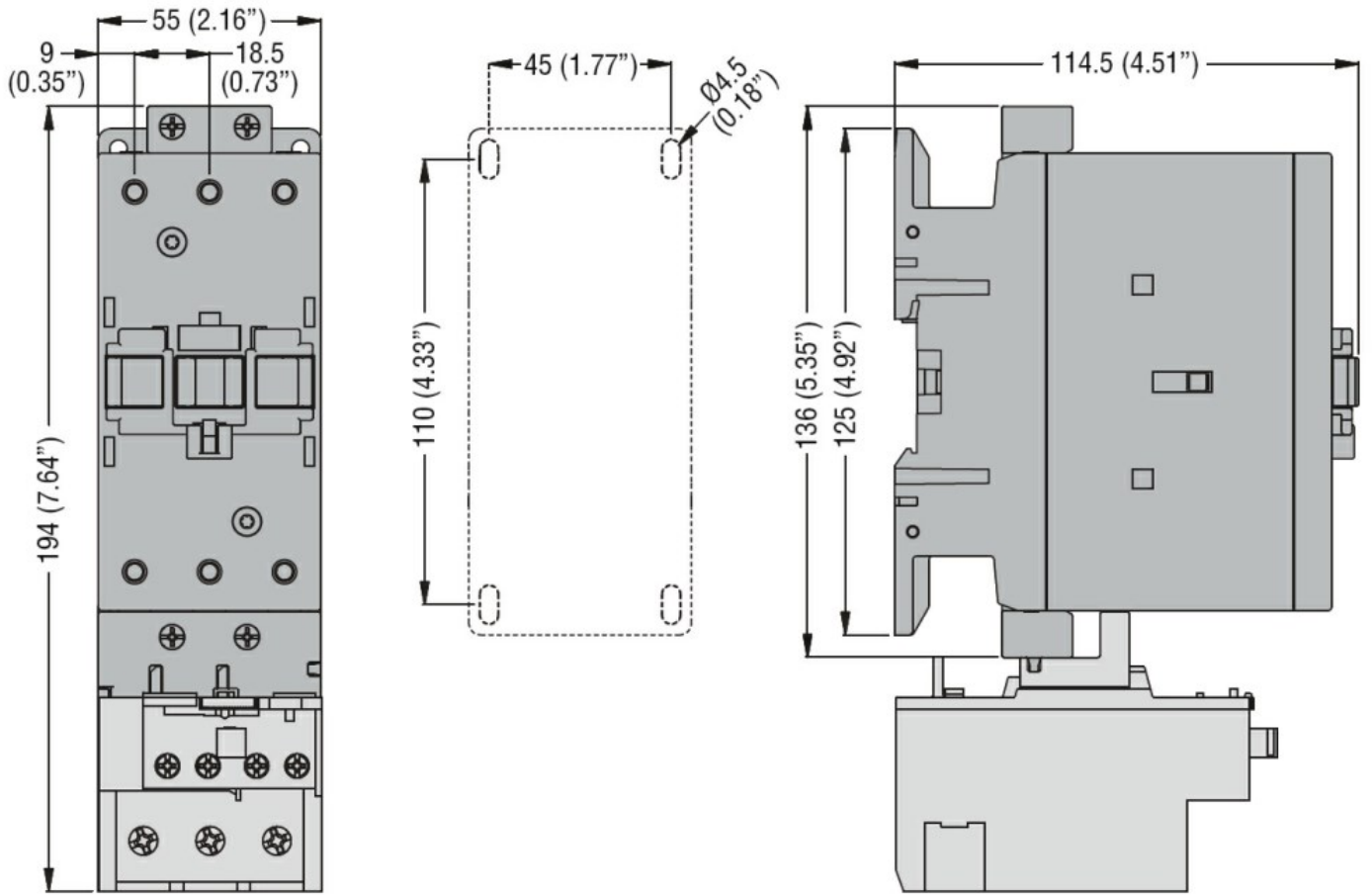

### Wiring diagrams

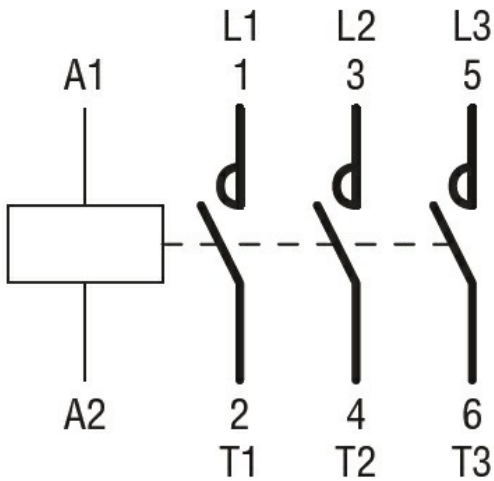

### Certifications and compliance

#### Compliance

CSA C22.2 n° 60947-1  
 CSA C22.2 n° 60947-4-1  
 IEC/EN/BS 60947-1  
 IEC/EN/BS 60947-4-1  
 UL 60947-1  
 UL 60947-4-1

#### Certificates

CCC

---

cULus

ETIM classification

ETIM 8.0

EC000066 -  
Power contactor,  
AC switching